

OPEN CLAMSHELL

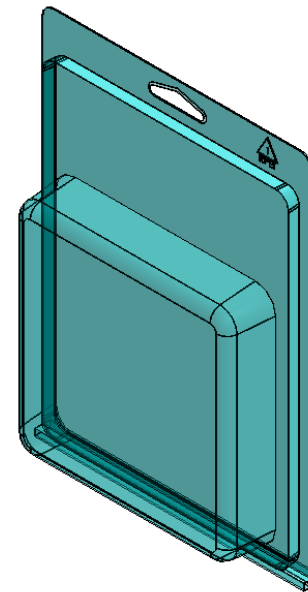

NOTE:  
 ALL MATERIAL THICKNESS IS  $\pm 10\%$  PRIOR TO FORMING  
 DRAFT ANGLES  $5^\circ$  TYP.  
 ALL DIMENSIONS  $\pm .025$  UNLESS NOTED  
 FLANGE  $\pm .047$

INFORMATION CONTAINED IN THIS DRAWING IS CONFIDENTIAL AND IS THE PROPERTY OF ANDEX

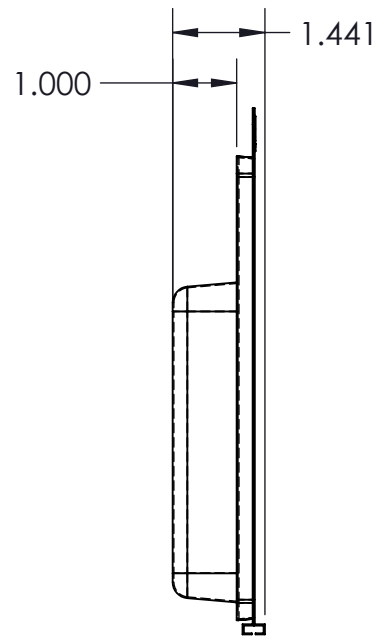
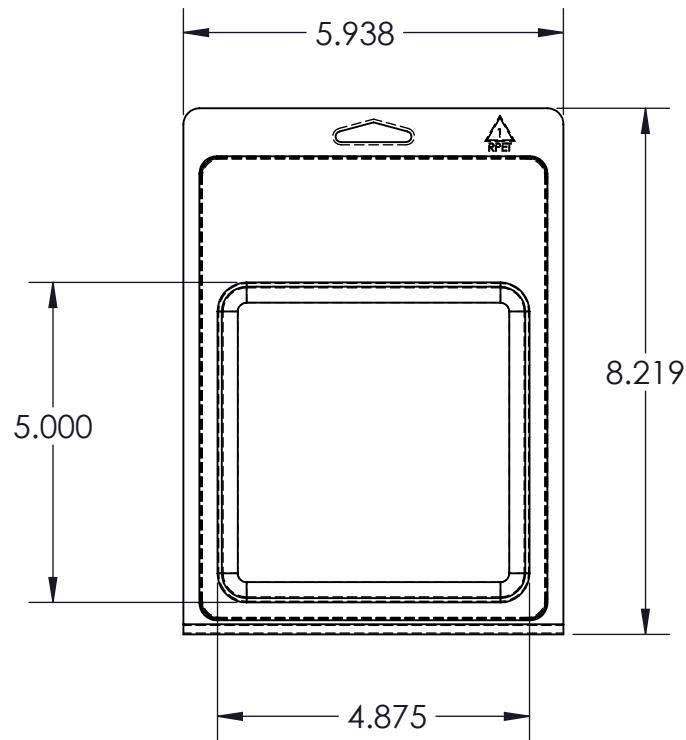

1911 FOURTH AVE. NORTH  
 ESCANABA, MI 49829

CUSTOMER  
**ANDEX STOCK**

DESCRIPTION  
**CLAMSHELL, 1.0 DP**

DRAWN: **J. HOLM**

SIZE: **A**

DWG # **5042**

REV:

DATE: **12/13/2013**

SCALE: **1:3**

MAT: **20 MIL RPET**

SHEET: **1 OF 1**