

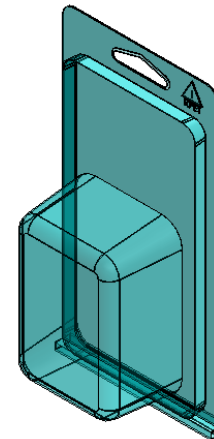

OPEN CLAMSHELL

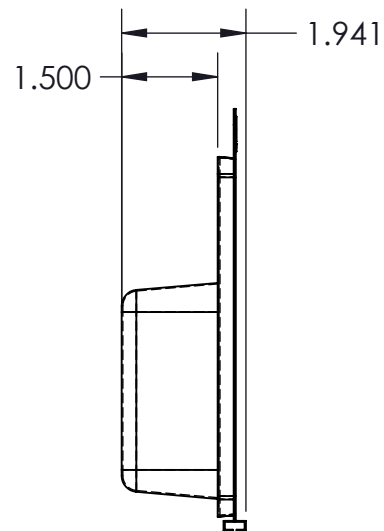
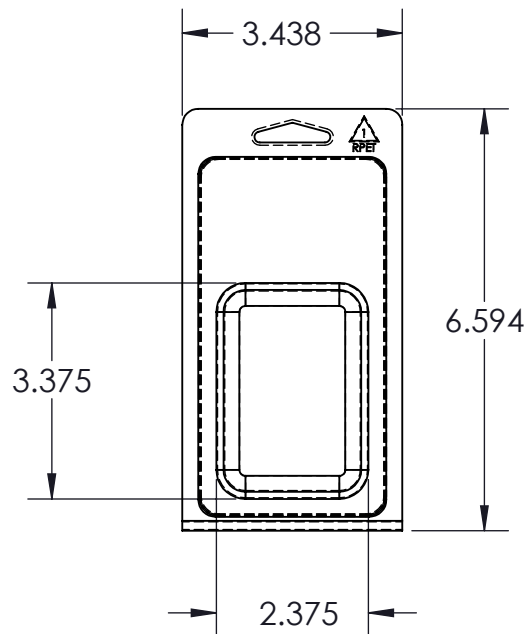

<p>NOTE: ALL MATERIAL THICKNESS IS $\pm 10\%$ PRIOR TO FORMING DRAFT ANGLES 5° TYP. ALL DIMENSIONS $\pm .025$ UNLESS NOTED FLANGE $\pm .047$</p>	INFORMATION CONTAINED IN THIS DRAWING IS CONFIDENTIAL AND IS THE PROPERTY OF ANDEX			
	 1911 FOURTH AVE. NORTH ESCANABA, MI 49829		CUSTOMER ANDEX STOCK	
			DESCRIPTION CLAMSHELL, 1.5 DP	
	DRAWN: J. HOLM	SIZE: A	DWG # 5003	REV:
DATE: 12/13/2013	SCALE: 1:3	MAT: 20 MIL RPET	SHEET: 1 OF 1	