

OPEN CLAMSHELL

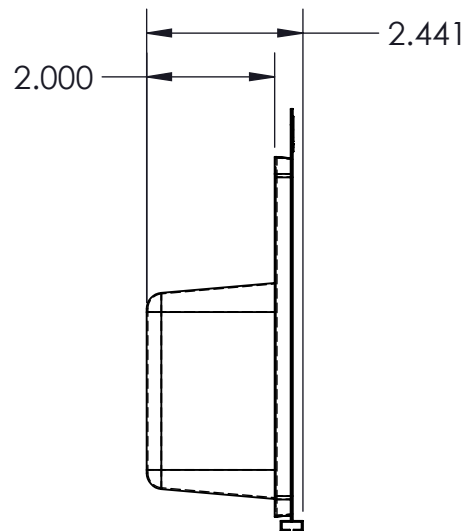

NOTE:
 ALL MATERIAL THICKNESS IS $\pm 10\%$ PRIOR TO FORMING
 DRAFT ANGLES 5° TYP.
 ALL DIMENSIONS $\pm .025$ UNLESS NOTED
 FLANGE $\pm .047$

INFORMATION CONTAINED IN THIS DRAWING IS CONFIDENTIAL AND IS THE PROPERTY OF ANDEX

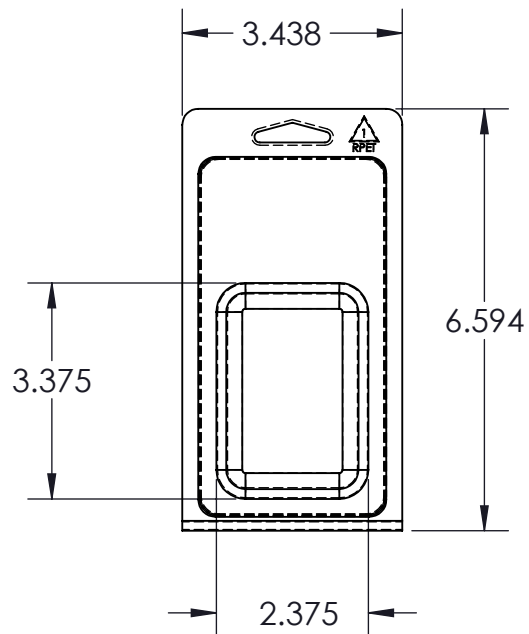

1911 FOURTH AVE. NORTH
 ESCANABA, MI 49829

CUSTOMER
ANDEX STOCK

DESCRIPTION
CLAMSHELL, 2.0 DP

DRAWN: J. HOLM	SIZE: A	DWG # 5004	REV:
DATE: 12/13/2013	SCALE: 1:3	MAT: 20 MIL RPET	SHEET: 1 OF 1